

INSTRUCTION MANUAL

QUARTZ TIME RECORDER
QR-9000

Introduction

Thank you for purchasing a QR-900 Quartz Time Recorder. Please read this manual carefully to gain the most benefit from this recorder.

Bescheinigung des Herstellers/Importeurs

Dies Gerät entspricht den Bedingungen der Niederspannungs-Vorschrift 73/23/EEC und dem EMVG nach 89/336/EEC.

This unit complies with the Low Voltage Directive 73/23/EEC and the EMC Directive 89/336/EEC.

Maschinenlärminformationsverordnung 3. GSGV, 18.01.1991: Der arbeitsplatzbezogene Schalldruckpegel beträgt 70 dB(A) oder weniger gemäß ISO 7779.

Die zugehörige Steckdose muß nahe beim Gerät angebracht und leicht zugänglich sein.

1. All rights reserved. No part of this manual may be photocopied or reproduced in any form or by any means without prior written consent.
2. All information included herein is subject to change without prior notice.
3. This manual has been prepared with extreme care, but if you have any questions or find any mistakes, please contact us.
4. We will not be held liable for any direct or indirect damages stemming from or with the use of this manual, even for reasons described in Item 3.

CONTENTS

- 1. FEATURES 1

- 2. BEFORE USING YOUR TIME RECORDER 3
 - Package Contents 3
 - Environmental Conditions 4
 - Names and Functions of All Parts 5
 - Adjusting Card Guide Width 7
 - Adjusting Print Position 8
 - Adjusting Print Head Position 10
 - Ribbon Cassette Installation 11

- 3. SETTING INSTRUCTIONS 12
 - Settings 12
 - Setting the Date and Time 13
 - Setting the Closing Day 15
 - Setting the Day Advance Time 17
 - Setting the Blank Line 18
 - Setting the External Alarm Time 19
 - Setting the Daylight Saving Time 21
 - Setting the Random Generator 22
 - Setting the Password 23
 - Setting the Column Key Lock 24
 - Setting the List Print 25
 - Setting the Print Prohibited Day 28
 - Setting the Weekly Program 29
 - Setting the DIP Switch 31
 - Setting the List of Time Cards 34

- 4. OPERATING INSTRUCTIONS 35
 - Print Column Selection 35

- 5. MASTER CLOCK CONNECTION PROCEDURE 36

- 6. EXTERNAL ALARM CONNECTION PROCEDURE 37

7. INSTALLING THE RECORDER ON A WALL OR TABLE	38
Wall-mounting Procedure	38
Installing the Recorder on a Table	39
8. TROUBLESHOOTING	40
If something is wrong with the recorder	40
List of error codes	40
9. SPECIFICATIONS	41
Time Card Specifications	42
10. PROGRAM TABLE	44

1. FEATURES

This Time Recorder is quiet and reliable time recorder for today's competitive work-place. Besides being sturdy and dependable, this Time Recorder speeds up clocking in and out lines, helps to enforce a time schedule and encourages good employee relationship. Here are it's most excelling features:

Smooth and quiet operation

Time cards are immediately inserted into the upper slot and printed by the dot matrix printer, and alignment is automatic.

Digital and analog display

Features a digital LCD on the operation panel and large analog display on the front.

2 color print

Schedule registrations are normally printed in black, while registration such as late arrivals and early departures are indicated in red ink.

Memory retention

The settings are retained for five years, including power-OFF times, with a built-in battery. If an optional NiCd battery is used, printing is possible up to 100 times (up to 24 hours) without using AC power.

Simple setting and operation

Items are classified by frequency of use to set them easily with DIP switches and rotary switches.

Various time card

Adaptable to any type of time card.

Day advance time

Day advance time can be programmed.

4 pay periods

Four different pay periods are available: weekly, bi-weekly, semi-monthly, or monthly.

Automatic differentiation of time card's front and back for S card

Auto-feed/auto eject mechanism

Perpetual calendar (programmed up to 2089)

Automatic daylight saving time setting

Slave clock functions

Random security search functions

Column key lock function

Print prohibited day setting
Program list printing

2. BEFORE USING YOUR TIME RECORDER

Package Contents

Checking the main unit and accessories

Open the package and check that the main unit and the following accessories are present.

Time Recorder Main Unit

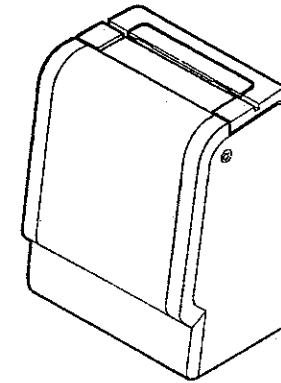

Instruction Manual



Ribbon Cassette

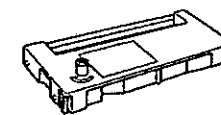
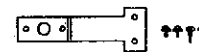

Table-mounting Fixtures



Key



Correction Label



Wall-mounting Fittings

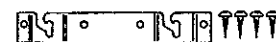

Wall-mounting Screw



Environmental Conditions

Do not install the time recorder in the following places:

- where humidity is high or dust accumulates
- where it is exposed to direct sunlight
- where there is violent or continuous vibration

Use the time recorder at the room temperature of -5°C to 45°C . Do not place it where the temperature changes abruptly.

If the time recorder is placed on a table, its height must be 70 to 80 cm. It can be wall-mounted. Use the supplied table-mounting fixtures or wall-mounting fittings.

The power supply must have the voltage and frequency shown on the label on the main unit. Plug the power cord into an electric outlet. Do not use any power supply with large voltage fluctuations. If you have any problem, contact your dealer. The settings are retained by the memory retention function even if power fails.

Names and Functions of All Parts

Card slot

When a time card is inserted into the card slot, it is drawn in automatically, and ejected automatically after printing.

Front cover

If you change settings or replace the ribbon cassette, open the front cover in the following manner:

(1) Set the key to the (O) position.

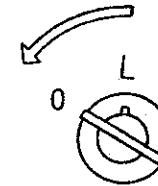

(2) Open the front cover toward you.
(To fully open it, raise the lever.)

(3) To close the front cover, return the key to the (L) position.

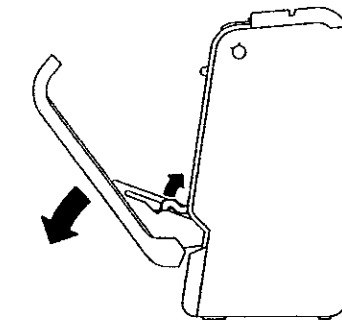
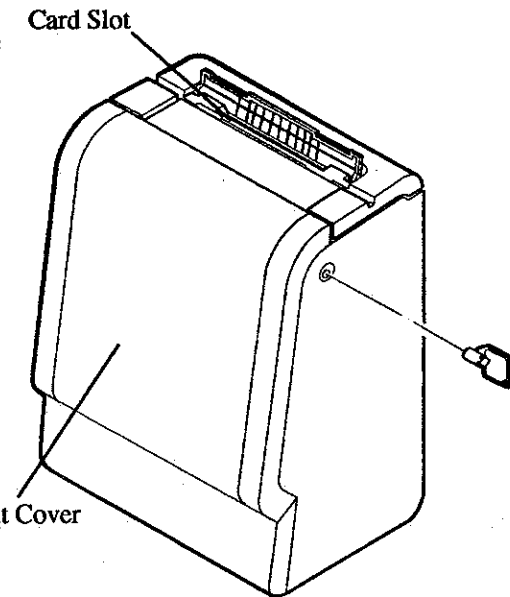
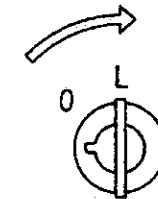

Keyboard

When the front cover is opened, the keyboard becomes visible and the recorder enters the setting mode. The panel has a rotary switch and column keys for setting programs. There are DIP switches at the front side of the panel.

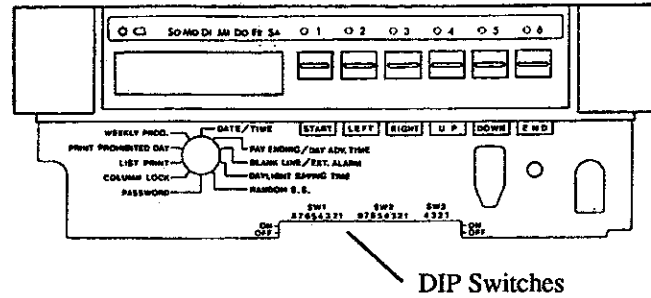

Battery case

To connect a Ni-Cd battery (option) for printing at power failure, place the recorder on a flat table on its back and open the bottom cover. Insert the battery, plug the connector, and close the cover as shown in the figure.

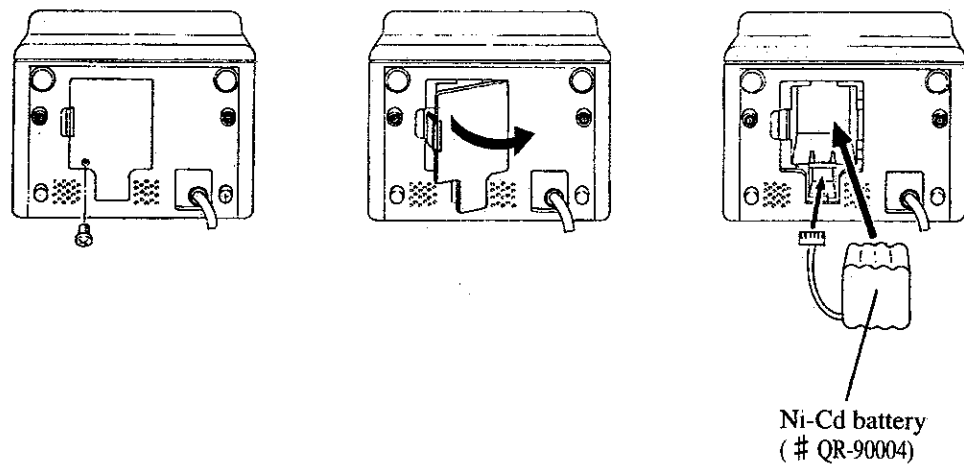

Caution

When the Ni-Cd battery is installed, it needs recharge by plugging in the power cord of the time recorder for at least two days.

MUST BE RECYCLED OR DISPOSED OF PROPERLY. USE SPECIFIED CHARGER.
WARNING : DO NOT put in fire, or mutilate ; may release toxic materials. DO NOT short circuit : may cause burns.

Adjusting Card Guide Width

1. Completely open the front panel.
2. Loosen the two screws (A) holding the upper right card guide and the one screw (B) holding the lower right card guide at the rear within the time recorder.

3. Align the card with the left edge of the card slot.

4. While observing the two openings (C) in the upper right card guide, align the right edge of the card with the corner of the square, and tighten the two screws (A).

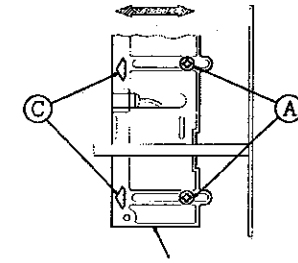

Upper Right Card Guide

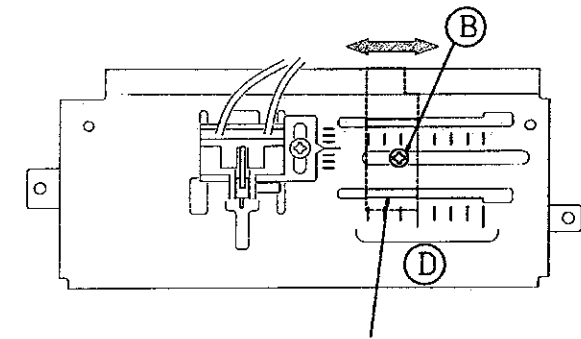
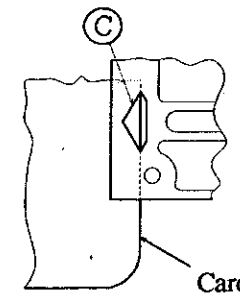

Lower Right Card Guide

5. Move the lower right card guide to the right edge with a card inserted. When the edge of the guide touches the card, move the guide back to the right by about 1 mm and tighten the screw (B).

When moving the card guide to the right by 1 mm, observe the scale (D) divided into 5-mm intervals on the plate on which the card guide is mounted.

Note: When this procedure is completed, the card guide width will be 1 mm greater than the card width. If there is no 1-mm space, cards may become jammed in the time recorder.

Adjusting Print Position

Vertical print position adjustment

1. Completely open the front panel.
2. Loosen the screw (A) holding the sensor holder in the lower center of the time recorder, and move the holder up or down to adjust the vertical print position.

For example, to move the print position upward by 2 mm, move the sensor holder down by 2 mm and tighten the screw (A).

When moving the sensor holder, observe the scale (B) divided into 2-mm intervals at the right side of the holder unit for reference.

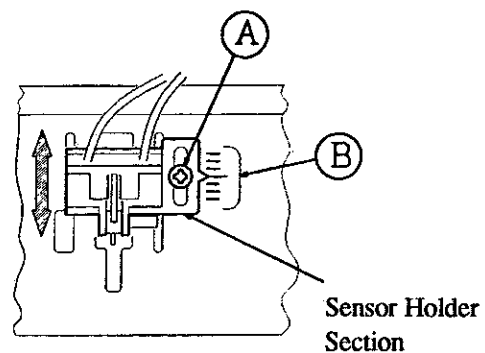

Note: The print position can be adjusted vertically within +/- 6 mm. However, short cards may not be accepted even if the sensor holder section is adjusted.

Horizontal print position adjustment

1. Completely open the front panel.
2. Loosen the screw (A) fixing the adjusting plate to the right side of the print head at the left side within the time recorder, and move the adjusting plate to the right or left to adjust the print position horizontally.

For example, to move the print position to the left by 1 mm, move the adjusting plate to the right by 1 mm and tighten the screw (A).

Note: The print position can be adjusted horizontally within +/- 1.5 mm.

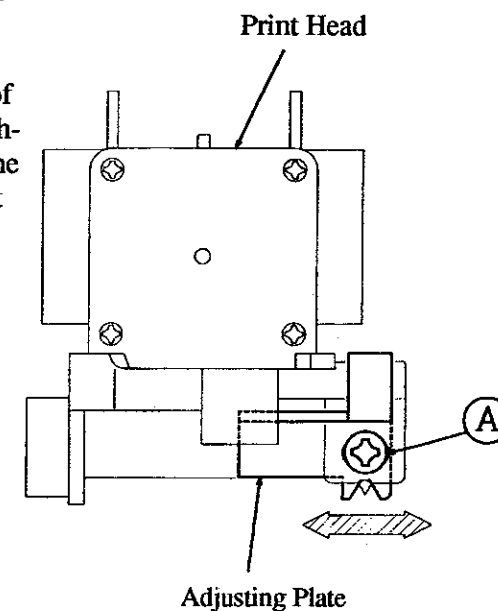

Adjusting Print Head Position

It is necessary to adjust the print head position according to the card thickness to prevent blurs and stains. Use the adjusting lever located at the right side in the main unit. It can be set to one of three positions: thin, standard, and thick.

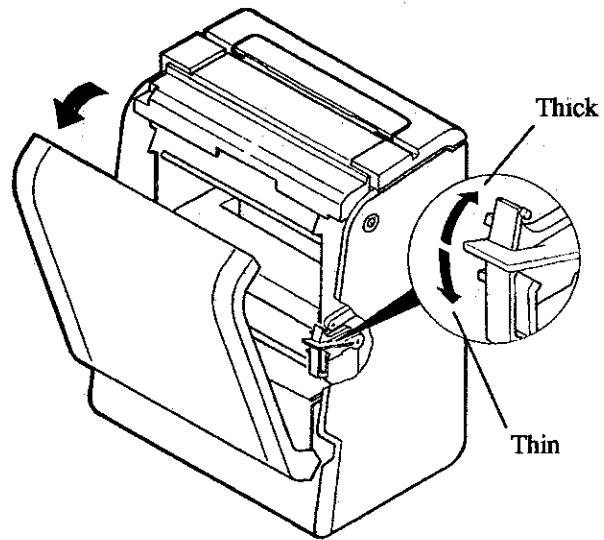

Ribbon Cassette Installation

1. Completely open the front panel.
2. Turn the ribbon cassette knob to eliminate slack in the ribbon.
3. Hold the ribbon cassette in the middle and place the ribbon between the print head and head mask. Then mate the right and left catches of the ribbon cassette with the projections (columns) and push the end of the cassette to fit it into place.

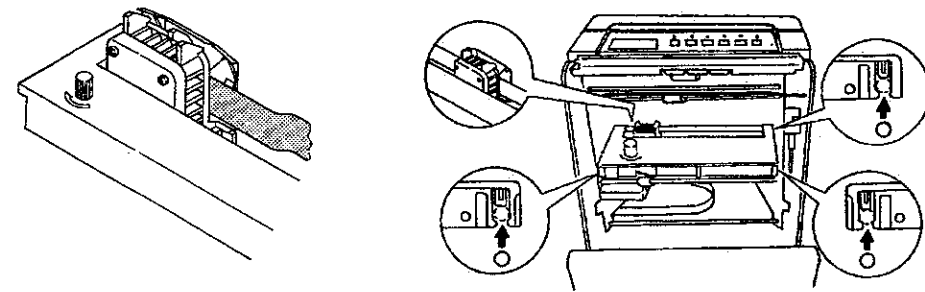

4. Turn the ribbon cassette knob again to eliminate slack in the ribbon.

Note: To replace the ribbon cassette with a new one, remove the old one, and push the white lever at the center of the recorder's rear right section to the right until it clicks, and then install a new ribbon cassette.

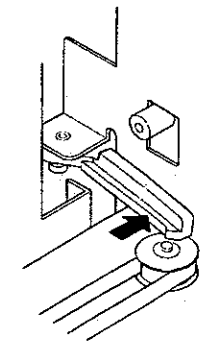

3. SETTING INSTRUCTIONS

Settings

- Turn the key to open the front cover.
- Select an item with the rotary switch. The following settings can be selected.
 - Date and time (DATE/TIME)
 - Closing day and day advance time (PAY ENDING/DAY ADV. TIME)
 - Blank line/external alarm time (BLANK LINE/EXT. ALARM)
 - Daylight saving time (DAYLIGHT SAVING TIME)
 - Random generator (RANDOM S. S.)
 - Password (PASSWORD)
 - Column key lock (COLUMN LOCK)
 - List Print (LIST PRINT)
 - Print prohibited day function (PRINT PROHIBITED DAY)
 - Weekly program (WEEKLY PROG.)
- Use column 1 to 6 keys to set parameters.
The following functions are assigned to column 1 to 6 keys for settings (when the front cover is open).

Column 1 key → START	Starts setting each item
Column 2 key → LEFT	Moves the blinking cursor on the LCD to the left.
Column 3 key → RIGHT	Moves the blinking cursor on the LCD to the right.
Column 4 key → UP	Changes (increase) the value.
Column 5 key → DOWN	Changes (decreases) the value.
Column 6 key → END	Sets the value.

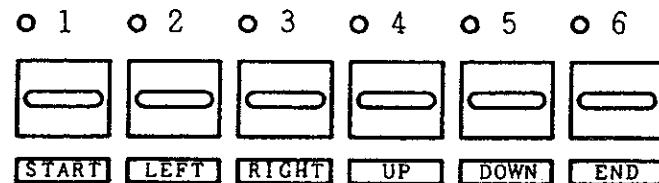

Setting the Date and Time

- Open the front cover and set the rotary switch to DATE/TIME.
The date (month-day-year) is displayed at the left (the date format can be changed with the DIP switch) and the "hour:minute:second" is displayed at the right.

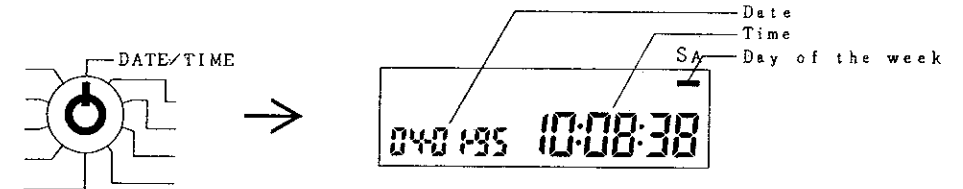

- Press the START key
The date starts blinking at the left.
A character can be entered in the blinking area.



- Set date.
Move the blinking cursor to the desired position with the LEFT and RIGHT keys and select a desired value with the UP and DOWN keys.
A bar (-) is displayed under the day of the week selected on the LCD.
– Display of the day of the week
Example: If the date is Friday January 20, 1995, set 01-20-95 .
Verify that the day of the week is correct.
- Set time.
Move the blinking cursor to the desired position with the LEFT and RIGHT keys and select a desired value with the UP and DOWN keys.
Since the time stops when the START key is pressed in (2), it must be set again.
Example: If the time is 1:00 p.m., set the time to "13:00:00". (24-hour format)

5. Verify that the date, day of the week, and time are correct, and press the END key. As soon as the END key is pressed, the clock takes effect (the second display is updated.)



6. Close the front cover. The analog clock restarts and shows the time specified in (1) to (4).

Setting the Closing Day

1. Open the front cover and set the rotary switch to PAY ENDING/DAY ADV. TIME. The closing day (month-day-year) is displayed at the left (the date format can be changed with the DIP switch) and the day advance time (hour:minute) is displayed at the right.

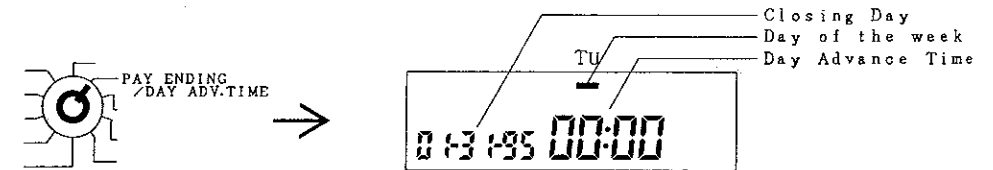

2. Press the START key. The closing day blinks. A character can be entered into the blinking character position.



3. Set the closing day.
- If the account is closed monthly
Select the closing day with the UP and DOWN keys. The year and month may be omitted.
Example: If the account is closed monthly, set 31 for the date.
 - If the account is closed at every two weeks
Enter the next closing day (month-day-year).
Move the blinking cursor to the desired position with the LEFT and RIGHT keys and select a desired value with the UP and DOWN keys.
Input the weekday if you wish to specify a day of the week for closing.
Example: If the next closing day is Sunday January 15, 1995, set the closing day to 01-15-95 .
Verify that a bar (-) on the top of the LCD indicates Sunday.
The closing day of every two weeks is automatically set based on the closing day entered.
 - If the account is closed weekly
Enter the next closing day (month-day-year).
If you wish to specify a day of the week for the closing day, enter the day of the week.

Example: If the closing day is Saturday:
 Since January 7, 1995, is Saturday, set 01-07-95.
 Verify that a bar (-) on the top of the LCD indicates Saturday.

- Verify that the closing day and day advance time are correct, and then press the END key.
 To change the day advance time, see Section "Setting the Day Advance Time".

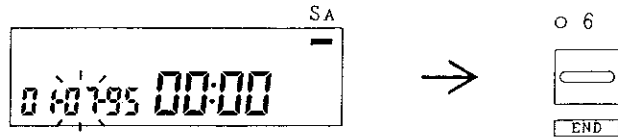

- Verify that the closing day and time card setting match.
 For details of time card setting, see Section "Setting the DIP Switch". (Select with SW2 1 to 4.)
 Example: The printer will not function properly if the closing day is set to the end of each month and the closing day of the time card is set to the end of every two weeks.

Setting the Day Advance Time

- Open the front cover and set the rotary switch to PAY ENDING/DAY ADV. TIME.
 The closing day (month-day-year) is displayed at the left (the date format can be changed with the DIP switch) and the day advance time (hour:minute) is displayed at the right.

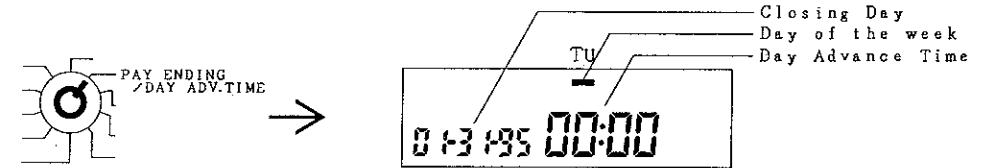

- Press the START key.
 The closing day display blinks.
 Press the LEFT and RIGHT keys to blink "hour:minute" of the day advance time.
 A character can be entered into the blinking character position.

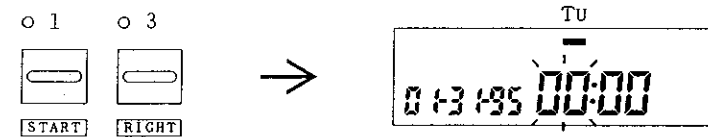

- Select day advance time.
 Select a desired value with the UP and DOWN keys.
 Example: If the day advance time is 5:00 a.m., set the time to "05:00" (in 24-hour format).
- Verify that the closing day and day advance time are correct, and then press the END key.
 To change the day advance time, see Section "Setting the Closing Day".

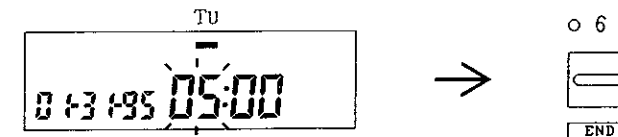

Setting the Blank Line

1. Open the front cover and set the rotary switch to BLANK LINE/EXT. ALARM. The blank line is displayed at the center and the external alarm time is displayed at the right.

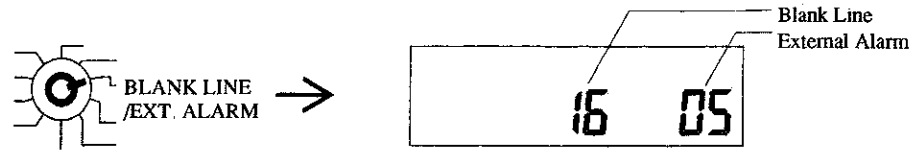

2. Press the START key. The blank line character blinks. A character can be entered into the blinking character position.

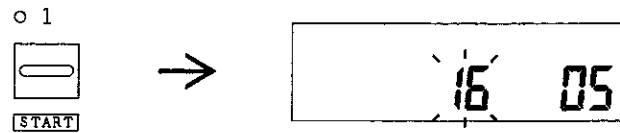

3. Select the blank line (not printed). Select a desired value with the UP and DOWN keys. Select 16 (initial value) for the S card.
4. Verify that the blank line and the external alarm time are correct, and press the END key. To change the external alarm time, see Section "External Alarm Time".

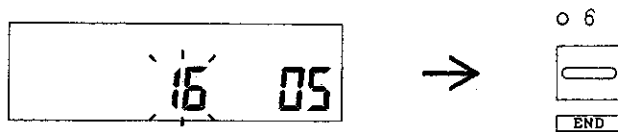

Example:

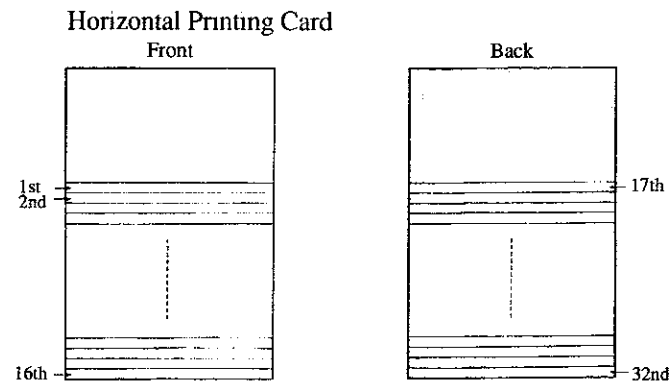

Vertical Printing Card

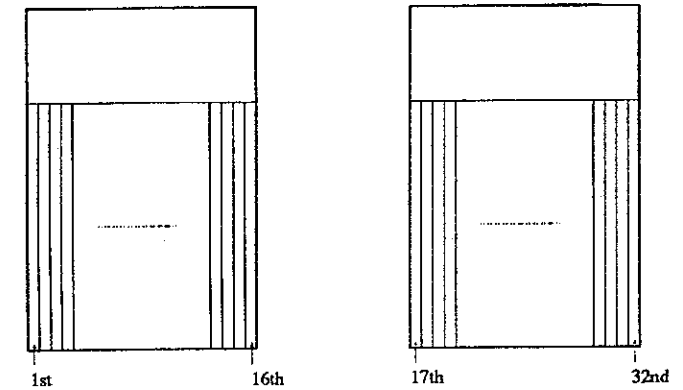

Setting the External Alarm Time

1. Open the front cover and set the rotary switch to BLANK LINE/EXT. ALARM. The blank line is displayed at the center and the external alarm time is displayed at the right.

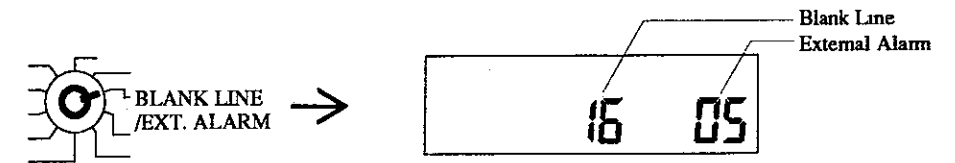

2. Press the START key. The blank line character blinks. Use the LEFT and RIGHT keys to make the external alarm blink. A character can be entered into the blinking character position.

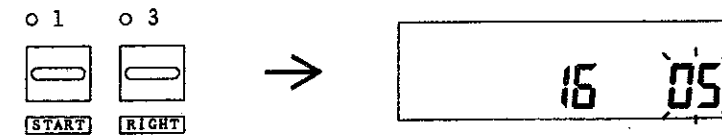

3. Set the external alarm time. Set with the UP and DOWN keys. Example: If the external alarm time is set to 30 seconds, select 30.

- Verify that the blank line and the external alarm time are correct, and press the END key.

To change the external alarm time, see Section "Setting the Blank Line".

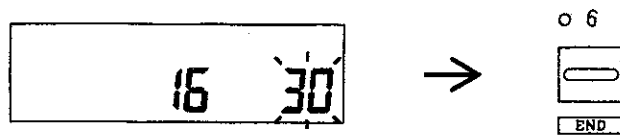

Setting the Daylight Saving Time

- Open the front cover and set the rotary switch to DAYLIGHT SAVING TIME. The daylight saving start time (month-day) appears at the lower left and the daylight saving end time (month-day) at the right.

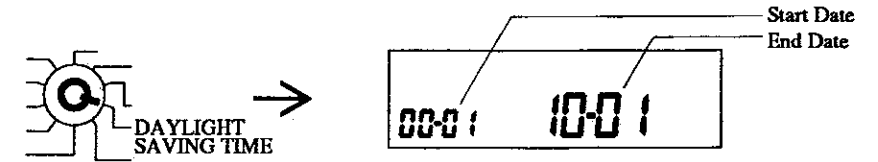

- Press the START key. The month of the daylight saving start time (month-day) blinks. A character can be entered into the blinking character position. Select a desired value with the UP and DOWN keys.



- Move the blinking cursor to the desired position with the LEFT and RIGHT keys and select a desired value with the UP and DOWN keys.

Example: If the daylight saving start time is Sunday ,March 26 and the end time is Sunday ,September 24 , set 03-26 09-24.

Set 00 for the month of the daylight saving start time (month-day) if there is no daylight saving time.

- Verify that the daylight saving start time (month-day) and end time (month-day) are correct, and then press the END key.

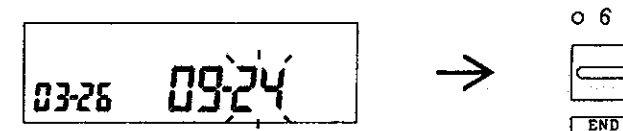

- If the current date falls within daylight saving time , the daylight saving time appears by a bar (-) at the top of the LCD when the front cover is closed.

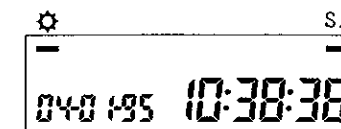

Setting the Random Generator

1. Open the front cover and set the rotary switch to the RANDOM S. S.
The "specified print column (0 to 22) - possibility (0 to 99%) - alarm time (0 to 9 seconds)" is displayed.

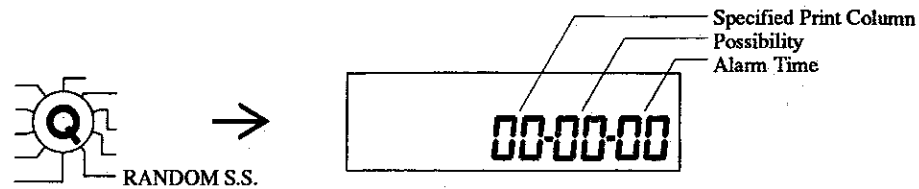

2. Press the START key.
The specified print column blinks.
A character can be entered into the blinking character position.
Select a desired value with the UP and DOWN keys.

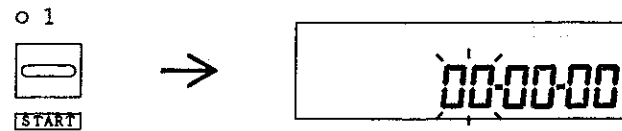

3. Move the blinking cursor to the desired position with the LEFT and RIGHT keys and select a desired value with the UP and DOWN keys.
If 00 is specified for the specified print column, all print columns are used for the random generator.
Example: If column 1 is used, set 01-50-05 in which the possibility is 50%, and the alarm time is 5 seconds.
If the random generator is not set, set 00 for the possibility and alarm time.

4. Verify that the specified print column, possibility, and alarm time are correct, and then press the END key.



Setting the Password

1. Open the front cover and set the rotary switch to the PASSWORD.
A four-digit password appears.

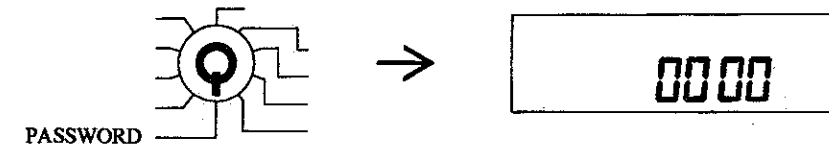

2. Press the START key.
The two higher-order digits of the password will blink.
Characters can be entered into the blinking character positions.
Select a desired value with the UP and DOWN keys.

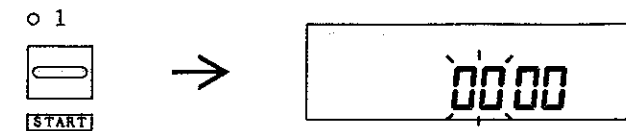

3. Move the blinking cursor to the two lower-order digits of the password with the LEFT and RIGHT keys and select a desired value with the UP and DOWN keys.
Example: If a password is set to 1234, input 1234.
If you do not wish to set any password, set 0000.

4. Verify that the password is correct, and then press the END key.

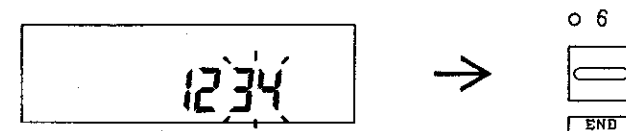

Setting the Column Key Lock

1. Open the front cover and set the rotary switch to COLUMN LOCK.
Two digits are displayed.



2. Press the START key.
The two digits blink.
Digits can be entered into the blinking cursor position.

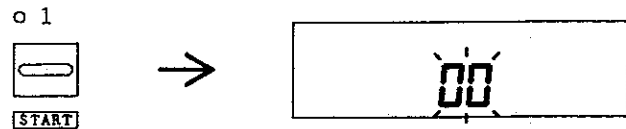

3. Set column key lock.
Select a desired value with the UP and DOWN keys.
00 → When a column key is pressed, the column takes effect (the column key is not locked).
01 → When a column key is pressed, the column is not effective (the column key is locked).
Print columns are specified in a program.
4. Verify that the column key lock setting is correct, and press the END key.

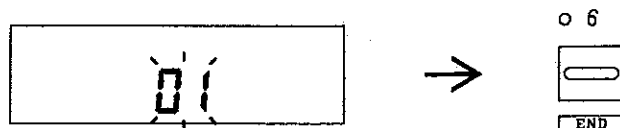

Setting the List Print

1. Open the front cover and set the rotary switch to LIST PRINT.
Two digits are displayed.

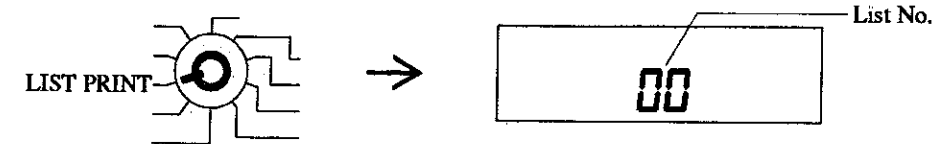

2. Press the START key.
The two digits will blink.
Digits can be input on the blinking cursors.

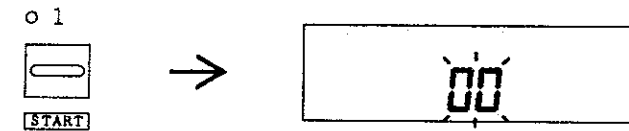

3. Specify a list to be printed.
Select a desired value with the UP and DOWN keys.
00 → Setting
01 → Print prohibited day using the print prohibited day setting
(See Section "Setting the Print Prohibited Day".)
02 → Program settings (programs No.01 to No.12)
03 → Program settings (programs No.13 to No.24)
04 → Program settings (programs No.25 to No.36)
05 → Program settings (programs No.37 to No.48)
4. Verify that the list print setting is correct, and press the END key.
5. Insert a card with the front cover open.
A list is printed as specified in (3) (see the figure below).

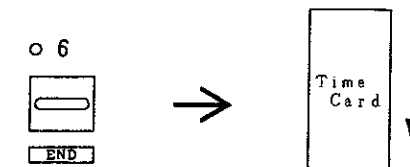

Example of print result of list 00

Print result	Description
000	→ List No.
950120 083000	→ Date Time
950131 0500	→ Closing day Day advance time
30 16 01	→ External alarm time Blank line Column key lock
030501 090501	→ Daylight saving start time End time (Note 1)
01 50 05	→ Random generator (Print column Possibility (%) Alarm time)
1234	→ Password
00100000	→ DIP switch 1 (1, 2, 3, ... 8)
00110000	→ DIP switch 2 (1, 2, 3, ... 8)
00000000	→ DIP switch 3 (1, 2, 3, 4)

} 0: OFF
} 1: ON

The last four digits are all zeros.

Note 1: 030501 represents the following:

03 05 01

Day of the week (01: Sun.; 02: Mon.; 03: Tue.; 04: Wed.;
05: Thur.; 06: Fri.; 07: Sat.)

Week (the fifth week)

Month (March)

Example of print results of list 01

(Print result)	(Description)
001	→ List No.
0101 0102	} Print prohibited day (0000: Not specified)
0115 0211	
0321 0429	
0503 0504	
0505 0915	
0923 1010	
1103 1123	
1223 0000	
0000 0000	

Example of print results of lists 02 to 04

(Print result)	(Description)
002	→ List No.
01 0111110 0830 01 2 1	} From the left: Program No. (01 to 12) Day of the week (Sunday, Monday, Tuesday, Wednesday, Thursday, Friday, Saturday from the left). 0: Not specified; 1: Specified Time (hour minute) Print column (00 to 22) Red/black print specification (0: Same as the previous setting; 1: Black; 2: Red) External alarm specification (0: OFF; 1: ON) (Note 2)
02 0111110 1730 02 1 1	
03 0000000 0000 00 0 0	
04 0000000 0000 00 0 0	
05 0000000 0000 00 0 0	
06 0000000 0000 00 0 0	
07 0000000 0000 00 0 0	
08 0000000 0000 00 0 0	
09 0000000 0000 00 0 0	
10 0000000 0000 00 0 0	
11 0000000 0000 00 0 0	
12 0000000 0000 00 0 0	

Note 2: 01 0111110 0830 01 2 1 in program 01 represents the following :

01 0111110 0830 01 2 1

External alarm (1: ON)

Red/black print specification (2: Red)

Print column specification (column 1)

Time (8:30 a.m.)

Day of the week (Monday to Friday)

Program No.01

Setting the Print Prohibited Day

1. Open the front cover and set the rotary switch to PRINT PROHIBITED DAY.
A number (01 to 18) is displayed at the upper left and the print prohibited day (month-day) at the right.
The number (01) blinks.
A character can be entered into the blinking character position.

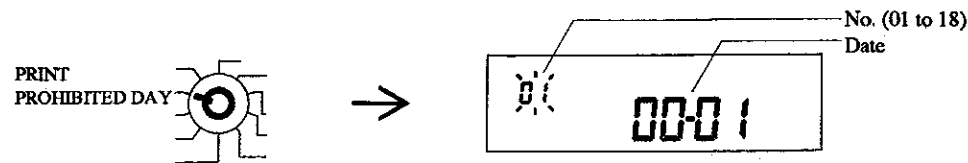

2. To change the number, select a desired value with the UP and DOWN keys.
3. Select a print prohibited day.
Move the blinking cursor to the desired position with the LEFT and RIGHT keys and select a desired value with the UP and DOWN keys.
Example: If January 1 is specified as a print prohibited day, set 01-01.
4. Verify that the print prohibited day setting is correct, and press the END key.
5. To set another print prohibited day, move the blinking cursor to the upper left number with the LEFT and RIGHT keys and repeat steps (2) to (4).
If a print prohibited day is not specified for a number, set the month to 00.
6. If all print prohibited days are specified, verify that the month-day displayed at the right is correct by changing the number with the UP and DOWN keys.

Setting the Weekly Program

1. Open the front cover and set the rotary switch to the WEEKLY PROG..
A program number (01 to 48) is displayed at the upper left, "Red/black print External alarm Print column" at the lower left, and the set time (hour:minute) at the right.
The program number (01) blinks.
A character can be entered into the blinking character position.

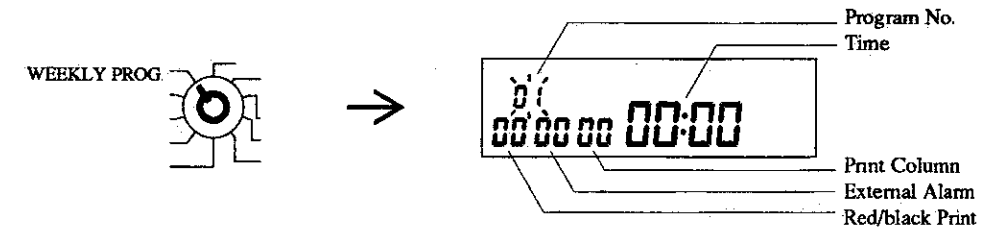

2. To change the program number, select a desired value with the UP and DOWN keys.
3. Select a value.
Move the blinking cursor to the desired position with the LEFT and RIGHT keys and select a desired value with the UP and DOWN keys.
– Select the day of the week to execute the settings.
Make the bar (-) on the top of the LCD (under the day of the week) blink with the LEFT and RIGHT keys.
When the UP key is pressed, a bar (-) appears, and when the DOWN key is pressed, the bar (-) disappears.
Example: To specify Sunday, Monday, Tuesday, Wednesday, Thursday, and Friday, make a bar (-) appear each under SU, MO, TU, WE, TH, and FR using the UP key.
– Red/black print specification
00 → Maintain the previous setting.
01 → Print in black
02 → Print in red
– External alarm setting
00 → External alarm OFF
01 → External alarm ON
– Print column specification
00 → Not specified
01 to 22 → Columns 1 to 22 are specified. (Columns 1 to 6 are specified for the S card.)

Example: To specify printing in red, external alarm ON, and print column 1, set the number so that 02 01 01 is displayed at the lower left.

* If a column key is pressed when a print column is specified here, the LED for the pressed key lights, and data is printed in the column corresponding to the pressed key. The LED for the specified print column lights up immediately or 15 seconds after printing.

To inhibit printing on columns not specified by the program, lock the columns as indicated in "Setting the Column Key Lock".

4. Select the time to execute the program specified in (3).

Make the hour:minute blink with the LEFT and RIGHT keys and select a desired value with the UP and DOWN keys.

Example: If the program execution time is 8:30 a.m., set 08:30 (24-hour format).

5. Verify that the settings, the execution time, and the specified days of the week are correct, and then press the END key.

6. To set another weekly program, move the blinking cursor to the upper left number with the LEFT and RIGHT keys and repeat steps 2 to 6.

7. If all the settings are specified, verify that the settings shown at the lower left, and the execution time and the days of the week shown at the right are correct by changing the program number with the UP and DOWN keys.

Do not specify two or more programs at the same time on the same day of the week.

Setting the DIP Switch

1. SW1

DIP switch SW1								Description
8	7	6	5	4	3	2	1	
-	-	-	-	OFF	OFF	-	-	Print display setting. Only time is displayed.
-	-	-	-	OFF	ON	-	-	Print display setting. Date and time are displayed.
-	-	-	-	ON	OFF	OFF	OFF	Print display setting. Day of the week (number 1) and time are displayed.
-	-	-	-	ON	OFF	OFF	ON	Print display setting. Day of the week (number 2) and time are displayed.
-	-	-	-	ON	OFF	ON	OFF	Print display setting. Day of the week (English) and time are displayed.
-	-	-	-	ON	OFF	ON	ON	Print display setting. Day of the week (French) and time are displayed.
-	-	-	-	ON	ON	OFF	OFF	Print display setting. Day of the week (German) and time are displayed.
-	-	-	-	ON	ON	OFF	ON	Print display setting. Day of the week (Italian) and time are displayed.
-	-	-	-	ON	ON	ON	OFF	Print display setting. Day of the week (Spanish) and time are displayed.
-	-	-	-	ON	ON	ON	ON	Print display setting. Day of the week (Japanese) and time are displayed.
-	-	OFF	OFF	-	-	-	-	Print display setting. Time display (60 divisions)
-	-	OFF	ON	-	-	-	-	Rounded time 1/100 H
-	-	ON	OFF	-	-	-	-	Rounded time 5/100 H
-	-	ON	ON	-	-	-	-	Rounded time 10/100 H
OFF	OFF	-	-	-	-	-	-	Date display setting. Year-month-day
ON	OFF	-	-	-	-	-	-	Date display setting. Month-day-year
OFF	ON	-	-	-	-	-	-	Date display setting. Day-month-year
ON	ON	-	-	-	-	-	-	Date display setting. Setting prohibited

2. SW2

DIP switch SW2								Description
8	7	6	5	4	3	2	1	
-	-	-	-	OFF	OFF	OFF	OFF	Card setting. Card type 1 (Stromberg: Weekly, one side)
-	-	-	-	OFF	OFF	OFF	ON	Card setting. Card type 2 (IBM. Weekly, one side)
-	-	-	-	OFF	OFF	ON	OFF	Card setting. Card type 3 (Simplex. Weekly, one side)
-	-	-	-	OFF	OFF	ON	ON	Card setting. Card type 4 (TAB card, 22 lines: Weekly, one side)
-	-	-	-	OFF	ON	OFF	OFF	Card setting. Card type 5 (TAB card, 16 lines: Weekly, one side)
-	-	-	-	OFF	ON	OFF	ON	Card setting. Card type 6 (Australia, 22 lines: Weekly, one side)
-	-	-	-	OFF	ON	ON	OFF	Card setting. Card type 7 (Australia, 16 lines. Weekly, one side)
-	-	-	-	OFF	ON	ON	ON	Card setting. Card type 8 (Stromberg. Bi-weekly, one side)
-	-	-	-	ON	OFF	OFF	OFF	Card setting. Card type 9 (IBM. Bi-weekly, one side)
-	-	-	-	ON	OFF	OFF	ON	Card setting. Card type 10 (Simplex. Bi-weekly, one side)
-	-	-	-	ON	OFF	ON	OFF	Card setting. Card type 11 (Seiko K card. Monthly, one side)
-	-	-	-	ON	OFF	ON	ON	Card setting. Card type 12 (SOLARI type. Monthly, one side)
-	-	-	-	ON	ON	OFF	OFF	Card setting. Card type 13 (Seiko S card. Monthly, both sides)
-	-	-	-	ON	ON	OFF	ON	Card setting. Card type 14 (BURK: Monthly, both sides)
-	-	-	-	ON	ON	ON	OFF	Card setting. Card type 15 (Kienzle: Monthly, both sides)
-	-	-	-	ON	ON	ON	ON	Card setting. Card type 16 (-. Monthly, four sides)
-	-	-	OFF	-	-	-	-	Print display setting. 24-hour display.
-	-	-	ON	-	-	-	-	Print display setting. A.M./P.M. display.
-	-	OFF	-	-	-	-	-	Master clock setting: Not used.
-	OFF	ON	-	-	-	-	-	Master clock setting: System 1 (Reversal in 30 seconds)
-	ON	ON	-	-	-	-	-	Master clock setting. System 2 (Reversal in 60 seconds)

3. SW3

DIP switch SW3 setting				Description
4	3	2	1	
OFF	OFF	OFF	OFF	Device number: None
OFF	OFF	OFF	ON	Device number 1
OFF	OFF	ON	OFF	Device number 2
OFF	OFF	ON	ON	Device number 3
OFF	ON	OFF	OFF	Device number 4
OFF	ON	OFF	ON	Device number 5
OFF	ON	ON	OFF	Device number 6
OFF	ON	ON	ON	Device number 7
ON	OFF	OFF	OFF	Device number 8
ON	OFF	OFF	ON	Device number 9
ON	OFF	ON	OFF	Device number 0
ON	OFF	ON	ON	Setting inhibited
ON	ON	OFF	OFF	Setting inhibited
ON	ON	OFF	ON	Setting inhibited
ON	ON	ON	OFF	Setting inhibited
ON	ON	ON	ON	Setting inhibited

(List of days of the week and their numbers)

	Sun.	Mon.	Tue.	Wed.	Thu.	Fri.	Sat.
No. of day of the week (Sun.-Sat.)	D1	D2	D3	D4	D5	D6	D7
No. of day of the week (Mon.-Sun)	D7	D1	D2	D3	D4	D5	D6
English	SU	MO	TU	WE	TH	FR	SA
French	DI	LU	MA	ME	JE	VE	SA
German	SO	MO	DI	MI	DO	FR	SA
Italian	DO	LU	MA	ME	GI	VE	SA
Spanish	DO	LU	MA	MI	JU	VI	SA
Japanese	日	月	火	水	木	金	土

Setting the List of Time Cards

Card type		Number of columns	Number of lines	Column pitch	Line pitch	Left margin	Bottom margin	Remarks
1	Weekly, single-side, horizontal print	Stromberg type	6	7	12 mm	6 mm	34.5 mm	[SEIKO W-7]
2		IBM type	6	7	12 mm	7 mm	23.5 mm	
3		Simplex type	6	7	14.3 mm	7.5 mm	14 mm	
4	Weekly, single-side, vertical print	TAB type	7	22	10.55 mm	4.35 mm	4 mm	27.5 mm
5		TAB type	7	16	10.55 mm	6 mm	4 mm	22 mm
6		—	7	22	12 mm	4.35 mm	7 mm	23 mm
7		—	7	16	12 mm	6 mm	7 mm	26 mm
8	Bi-weekly, single-side, horizontal print	Stromberg type	6	14	12 mm	6 mm	7 mm	35 mm [SEIKO W-14]
9		IBM type	6	14	12 mm	7 mm	7 mm	23 mm
10		Simplex type	6	14	14.3 mm	7.5 mm	5.5 mm	14 mm
11	Monthly, single-side, horizontal print	SEIKO K card	6	31	12 mm	4 mm	7 mm	14 mm
12		SOLARI type	6	31	12 mm	4.53 mm	7 mm	26 mm
13	Monthly, double-side, horizontal print	SEIKO S card	6	16	12 mm	6 mm	7 mm	23 mm
14		BÜRK type	6	16	12 mm	6 mm	10 mm	20 mm
15	Monthly, double-side, vertical print	KIENZLE type	16	22	6 mm	5 mm	5 mm	23 mm
16	Monthly, four sides, vertical print	—	8	22	10.7 mm	4.35 mm	6 mm	20 mm

Note: The cards whose left or bottom margins differ slightly from a left or bottom margin listed above may be used by adjusting them.

4. OPERATING INSTRUCTIONS

Print Column Selection

A print column may be selected manually.

1. Press the key corresponding to the column to be printed. The lamp above the column key lights.

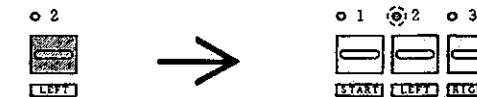

2. Insert the time card into the card slot to print. If the card is not the specified type of card, or if it is upside down, it may not be printed on.

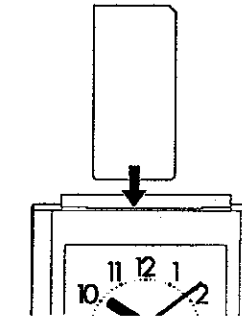

Note 1: If data is printed on a column other than the one specified by the program, the print head returns to the specified column automatically after printing. If no data is printed for about 15 seconds, the print head returns to the specified column automatically.

Note 2: If no program is specified, the selected print column remains effective until another key is selected or the day advance time is reached.

Note 3: If the day is set as a print prohibited day, printing cannot be performed unless the program is canceled.

Note 4: If the time recorder is operating on a NiCd battery (option) after power failure, the — mark is displayed below the □ mark on the LCD and column key lamp flashes.

5. MASTER CLOCK CONNECTION PROCEDURE

Open the back cover of the recorder and connect the signal line from the master clock to the terminal in the following manner:

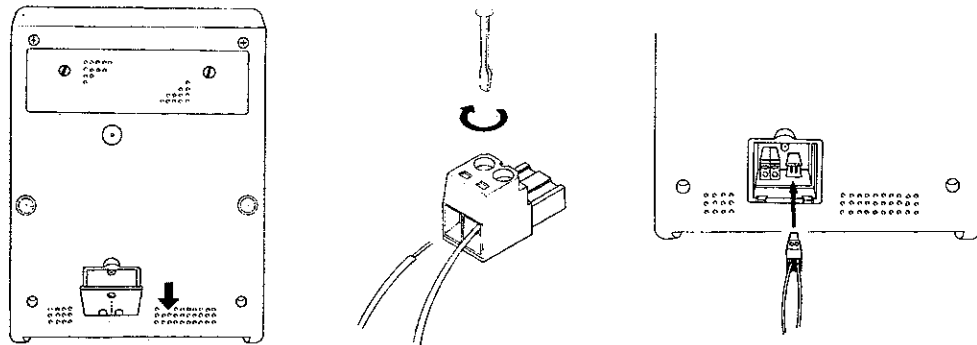
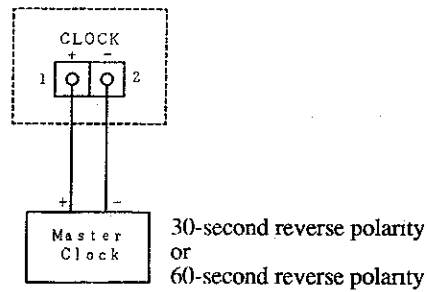

The time is modified at the day advance time.

Note: – 30-second reversal

Since the 30-second signal (-V side) is not received, the difference from the master clock is 30 seconds or more, and the time is not modified correctly.

– 60-second reversal

Since the odd-numbered signal (-V side) is not received, the difference from the master clock is one minute or more, and the time is not modified correctly.

Pulse specification	Input sensitivity
Pulse width	0.1 second or more
Voltage	6 to 32 V

6. EXTERNAL ALARM CONNECTION PROCEDURE

Open the back cover of the recorder and connect the signal line from the external alarm to the terminal in the following manner:

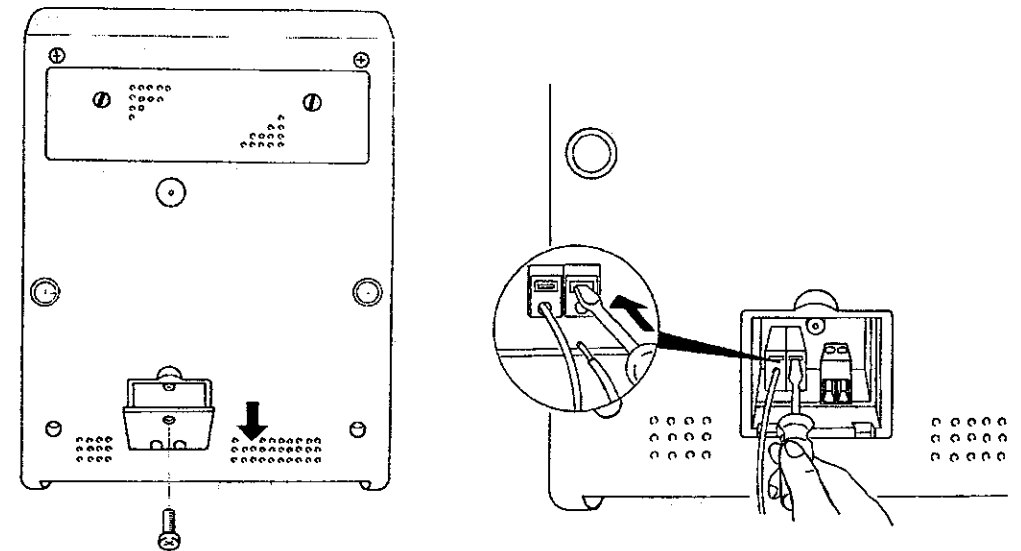
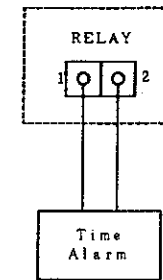

Rated load

Resistance load

Induction load

($\cos \phi = 1$)
DC 28 V 5 A

($\cos \phi = 0.4$)
($L/R = 7$ msec.)
DC 28 V 2.5 A

7. INSTALLING THE RECORDER ON A WALL OR TABLE

The time recorder may be installed on a wall or table with the supplied fixtures.

Wall-mounting Procedure

1. Install the wall-mounting fitting on the wall.

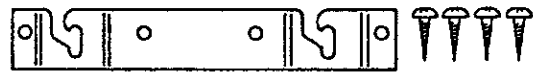

2. Hook the screw on the back of the time recorder in the groove of the wall-mounting fitting.
3. The recorder may be used now. If you wish to secure the recorder so as to prevent tampering or theft, break the cover on the convex part of the rear panel with a screwdriver before wall mounting, and secure it with the supplied wall-mounting screw after mounting the main unit.

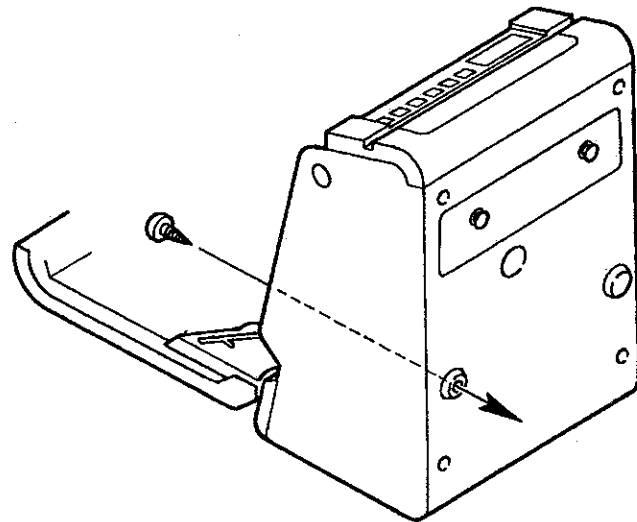

Installing the Recorder on a Table

1. Mount the table-mounting fixture on the bottom of the recorder with the two small screws. Determine the installation direction according to the installation location.
2. Secure the recorder on the table with the two large screws.

8. TROUBLESHOOTING

If Something Is Wrong with the Recorder

Symptom	Check Item
<ul style="list-style-type: none"> •Does not work at all. •The card is not drawn in. 	<ul style="list-style-type: none"> *Is the power cord plugged into an outlet with the correct voltage? *Is it a print prohibited day?
<ul style="list-style-type: none"> •Does not print. •Color mixture 	<ul style="list-style-type: none"> *Is the ribbon cassette installed correctly?
Print position error	<ul style="list-style-type: none"> *Check the card type and the closing day setting *Is the time card folded or bent?

List of Error Codes

Error No.	Error description	Remedy
E-03	The card is upside down.	Turn it over and insert it again
E-04	The card type is wrong. (The card is short.)	Insert the correct card or change the setting.
E-05	The card is not drawn in.	Insert the card again.
E-20	A print column designated by the weekly program is beyond the limits of print area.	Change the weekly program or the card setting.
E-30	The home sensor does not work correctly.	Install the ribbon cassette correctly.
E-31	The card is not ejected.	Open the front cover and check whether the card jams.

* If an error occurs again after taking on appropriate measure, contact your dealer.

9. SPECIFICATIONS

Clock	Analog (two hands) and digital (date and time)
<i>Precision</i>	Average monthly rate ± 10 sec. (in the normal temperature range)
Automatic adjustment at the end of month	Automatic adjustment of days of the week, end of the month, and leap years with perpetual calendar function (until 2089)
Ribbon cassette	Two colors (black and red); fabric ribbon cassette
Printing	
<i>Method</i>	Dot matrix
<i>Color</i>	Two colors (black and red)
External contact	Non-voltage contact
Memory retention	Five years, including power-OFF times
Printing at power failure	Can print up to 100 times (up to 24 hours) with a special NiCd battery (option).
Operating conditions	Temperature: -5 to 45°C; Humidity: 20% to 90% RH (no condensing)
	Print quality is not guaranteed at temperatures below 5°C.
Size	240 (width) \times 327 (height) \times 185 (depth)
Weight	Approximately 5 kg

Time Card Specifications

S Card (double-sided)

Front Side

Reverse Side

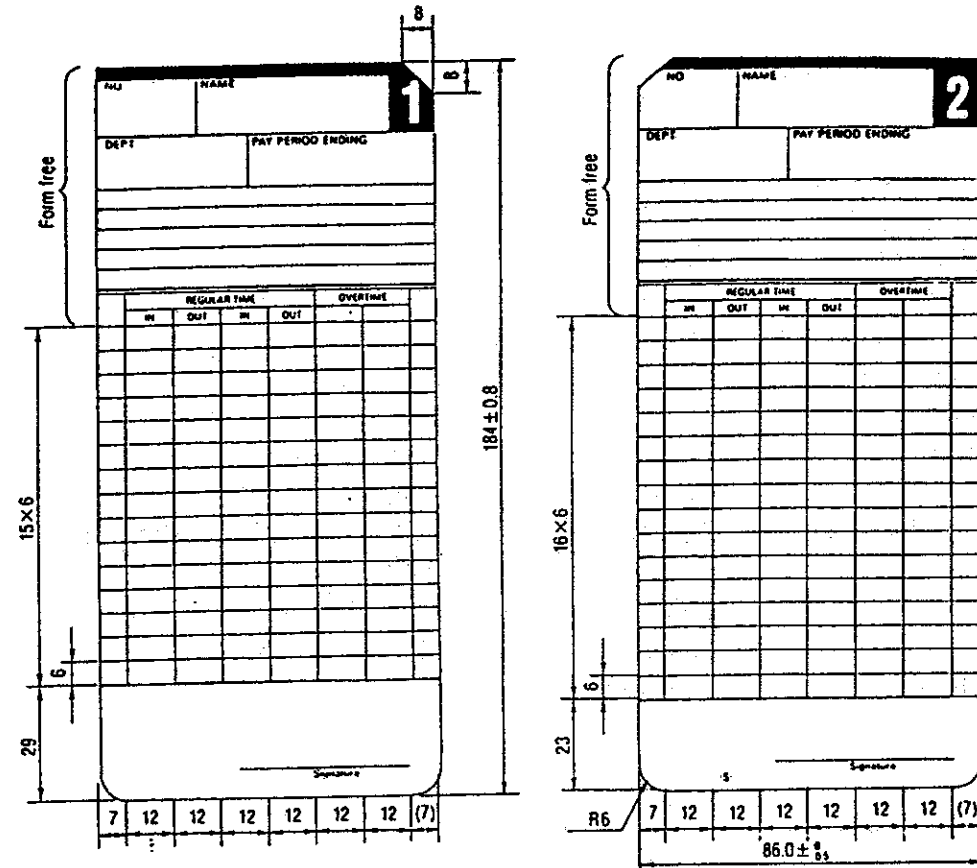

Note: Recommended Paper Thickness: 0.45 ± 0.05 mm

K Card (single-sided)

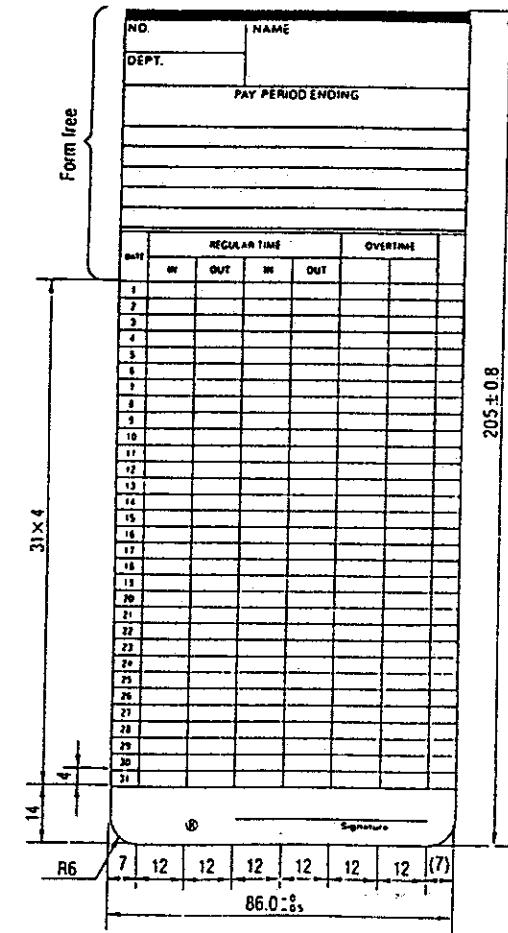

Note: Thickness : 0.5 ± 0.06 mm

10. PROGRAM TABLE

Make copies of this table and use it for your WEEKLY PROGRAM.

Step	Day of the Week	Time	Red Printing	Black Printing	Ext. Alarm	Print column	Remarks
01		:					
02		:					
03		:					
04		:					
05		:					
06		:					
07		:					
08		:					
09		:					
10		:					
11		:					
12		:					
13		:					
14		:					
15		:					
16		:					
17		:					
18		:					
19		:					
20		:					
21		:					
22		:					
23		:					
24		:					

Step	Day of the Week	Time	Red Printing	Black Printing	Ext. Alarm	Print column	Remarks
25		:					
26		:					
27		:					
28		:					
29		:					
30		:					
31		:					
32		:					
33		:					
34		:					
35		:					
36		:					
37		:					
38		:					
39		:					
40		:					
41		:					
42		:					
43		:					
44		:					
45		:					
46		:					
47		:					
48		:					

MEMO

QR-900
Instruction Manual
